

# JOIST

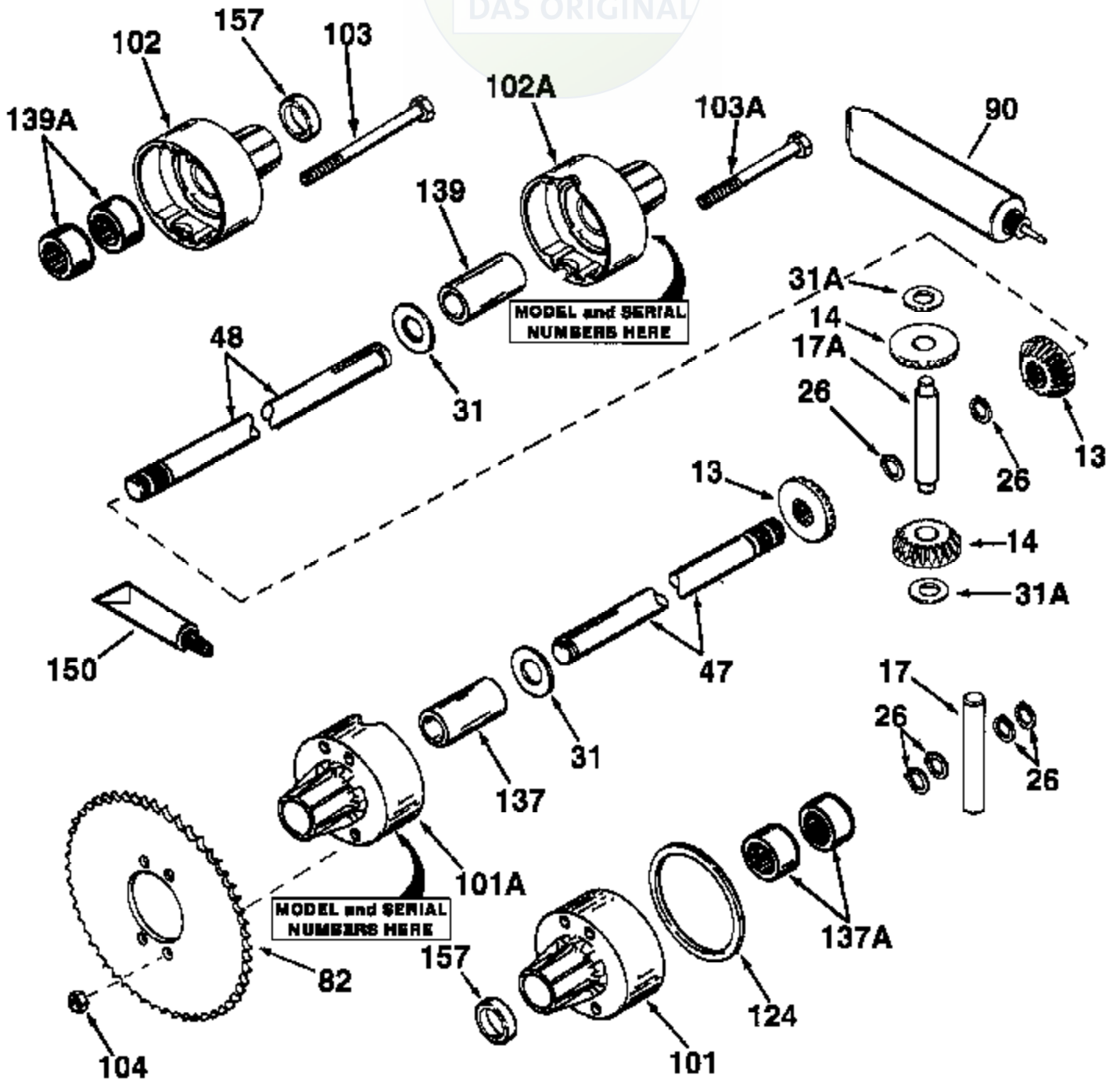

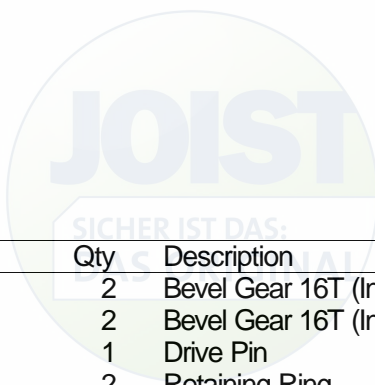





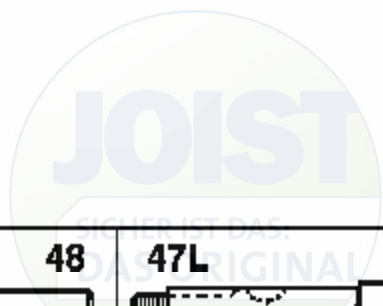

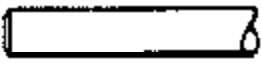
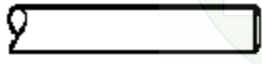
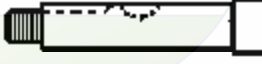
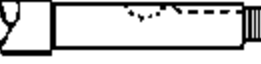
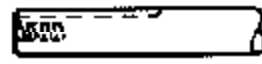

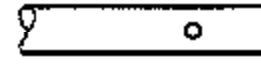

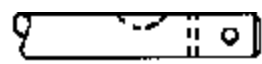
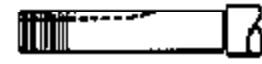
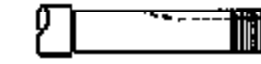
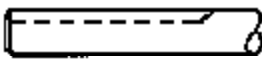

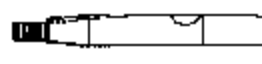
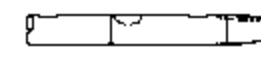
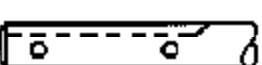

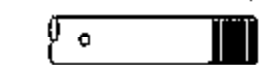
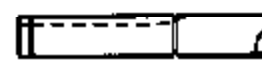
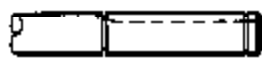
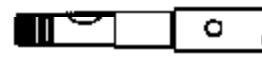
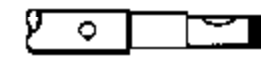
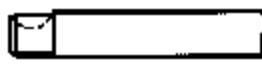
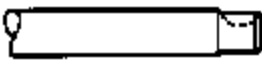

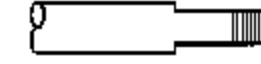
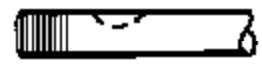
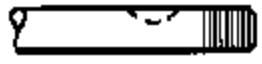

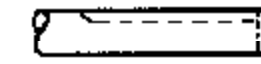
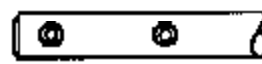
SICHER IST DAS:  
DAS ORIGINAL

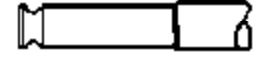

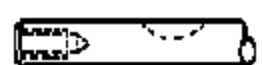
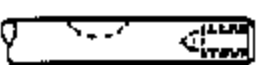
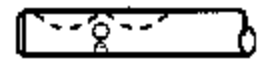
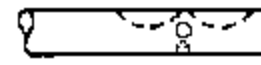

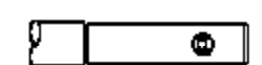
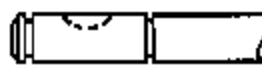
Ref #	Part Number	Qty	Description
13	778326	2	Bevel Gear 16T (Incl. 14)
14	778326	2	Bevel Gear 16T (Incl. 13)
17A	786040	1	Drive Pin
26	792018	2	Retaining Ring
31	780045	2	Washer 1.002ID .061W
31A	780096	2	Washer .625 ID .057W
32	788105	6	O-Ring .176ID
82	786041A	1	Optional Sprocket 45T, 7.389OD
82	786042	1	Optional Sprocket 40T, 6.650OD
82	786043	1	Optional Sprocket 54T, 8.823OD
82	786051	1	Optional Sprocket 60T, 9.841OD
82	786070	1	Optional Sprocket 48T, 7.920OD
90	788067B	1	Grease 100-100-200A 2.14 Peerless #1 92 bottle Bentonite greas e)
101A	775014	1	Differential Carrier (Incl. 137)
102A	775015	1	Differential Carrier (Incl. 139)
103A	792104A	2	Screw 5/16-18 X 2"
103	792041	4	Screw 5/16-18 x 3.750"
104	792042	4	Locknut 5/16-18
124	788055	1	Gasket
137	780198	1	Bushing 1.003"
139	780198	1	Bushing 1.003"
157	788007	2	Oil Seal 1"

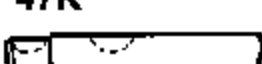
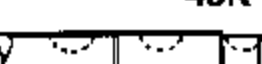
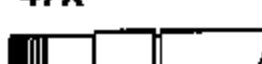

<b>47</b> 	<b>48</b> 	<b>47L</b> 	<b>48L</b> 
<b>47A</b> 	<b>48A</b> 	<b>47M</b> 	<b>48M</b> 
<b>47B</b> 	<b>48B</b> 	<b>47N</b> 	<b>48N</b> 
<b>47C</b> 	<b>48C</b> 	<b>47P</b> 	<b>48P</b> 
<b>47D</b> 	<b>48D</b> 	<b>47Q</b> 	<b>48Q</b> 
<b>47E</b> 	<b>48E</b> 	<b>47R</b> 	<b>48R</b> 
<b>47F</b> 	<b>48F</b> 	<b>47S</b> 	<b>48S</b> 
<b>47G</b> 	<b>48G</b> 	<b>47T</b> 	<b>48T</b> 
<b>47H</b> 	<b>48H</b> 	<b>47U</b> 	<b>48U</b> 
<b>47I</b> 	<b>48I</b> 	<b>47V</b> 	<b>48V</b> 
<b>47J</b> 	<b>48J</b> 	<b>47W</b> 	<b>48W</b> 
<b>47K</b> 	<b>48K</b> 	<b>47X</b> 	<b>48X</b> 

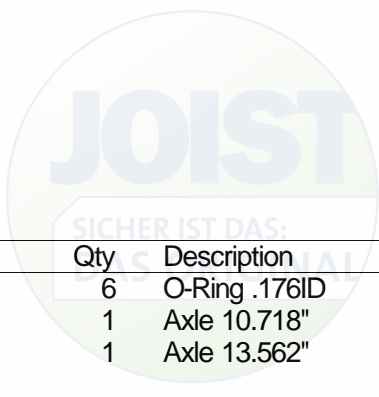

---

Ref #	Part Number	Qty	Description
32	788105	6	O-Ring .176ID
47L	775074	1	Axle 10.718"
48L	775075	1	Axle 13.562"

---